

S E A M L E S S G U T T E R

PRODUCT **Catalog**



GUTTER MACHINES

GUTTER COIL

GUTTER ACCESSORIES



Everything You Need To Make Seamless Gutters

Gutter System Components

1. Flat Strainer
2. Leaf Protection
3. Hidden Hanger
4. Canadian Bar Hanger
5. Drip Edge
6. Left End Cap
7. Gutter
8. Fascia Hanger
9. Box Mitre Inside
10. Box Mitre Outside
11. Gutter Wedge
12. Wrap Around Hanger
13. Right End Cap
14. Round Pop-in Outlet
15. Oval Outlet
16. A Elbow
17. A Elbow
18. Pipe Band
19. Leader
20. A Elbow
21. B Elbow
22. Brick Offset
23. Leader Head
24. Funnel
25. Adapter
26. Splash Block
27. U-Clip
28. Pipe Band
29. Zip Screw
30. Rivet
31. Spike
32. Ferrel
33. Inside Strip Mitre
34. Outside Strip Mitre
35. Inside Bay Mitre
36. Outside Bay Mitre
37. Gutter Coil
38. Sealants/Caulking
39. Sealants/Caulking
40. Touch-up Paint

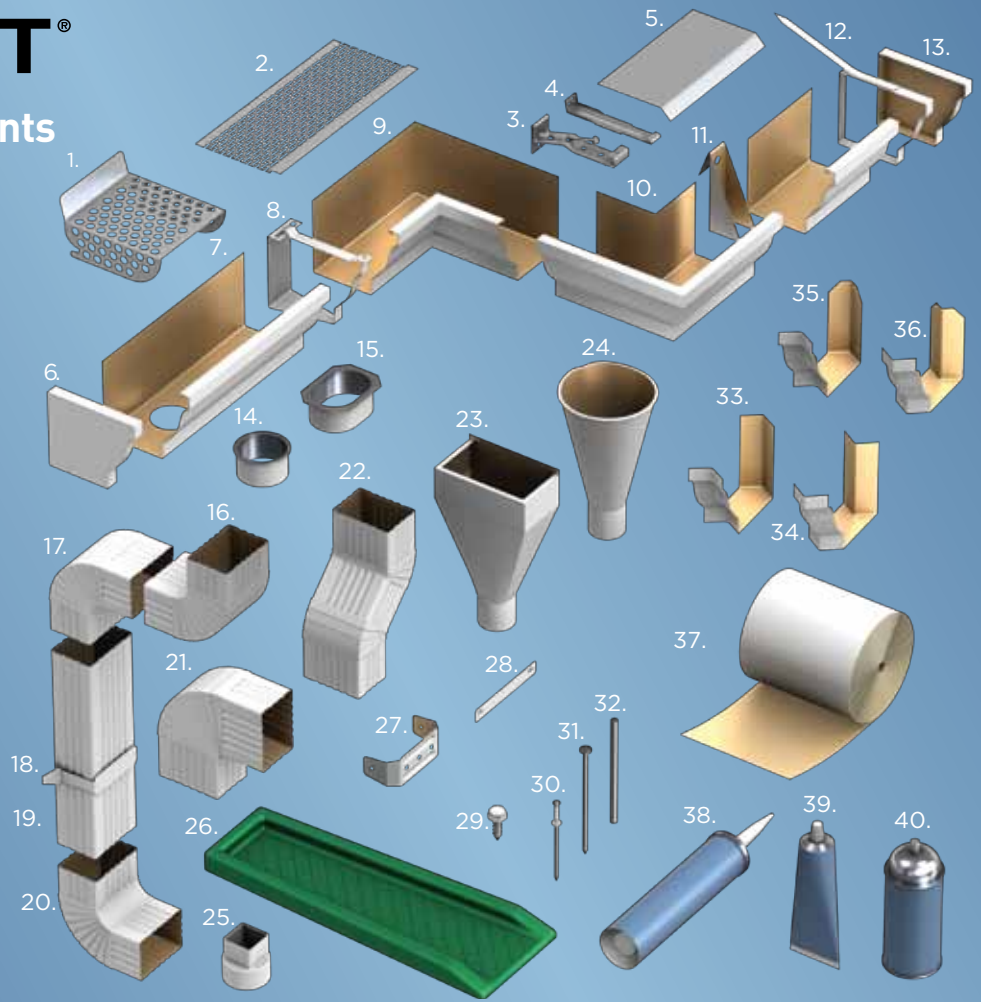

Custom Gutter Colors

Englert gutters are painted on our own in-house coil coating line - one of the most technically advanced paint lines in the industry under the supervision of experienced craftsmen.

All Englert gutters are coated with our Castleclad, proprietary two coat paint system that resists dirt adhesion, is easy to clean and provides excellent color retention.

Choose from a selection of vibrant colors!*

** Printing processes vary - the colors above are printed in ink and may not represent the actual painted coil color - please contact your local Englert representative and request a color card or actual color chips before ordering.*



Seamless Gutter Product Catalog - Table Of Contents

Credit Application	1	Fasteners	12
Gutter Coil.....	3	Leaf Protection	13
Gutter Coil/Trim Coil	4	Accessories.....	14
Downspouts	5	Metal Man Forming Tools	17
Elbows.....	6	Metal Man Gutter Machines.....	20
End Caps.....	8	Architectural Guide Specifications.....	22
Mitres.....	9	Purchasing Tips.....	23
Mitres and Hangers	10	Maintenance Tips.....	25
Hangers.....	11		



APPLICATION AND TERMS FOR EXTENSION OF CREDIT
FOR THE PURPOSE OF OBTAINING MERCHANDISE FROM YOU ON CREDIT, THE FOLLOWING STATEMENT IN WRITING IS MADE, INTENDING THAT IT WILL BE RELIED UPON AS CORRECT.
FAX COMPLETED FORM TO: (732) 324-3958 OR EMAIL: credit@englertinc.com

Firm Or Trade Name	_____	Date	_____
Street	_____	City/State/Zip	_____
Kind of Business	_____	How Long in Business	_____
Business Telephone	() _____	Email Address	_____

() Individual () Partnership () Corporation

OFFICERS OR PARTNERS

Name and Title	_____	Name and Title	_____
Social Security No.	_____	Social Security No.	_____
Address	_____	Address	_____
Home Telephone	() _____	Home Telephone	() _____
Do You Own () Rent ()		Do You Own () Rent ()	

CURRENT BUSINESS REFERENCES: SUPPLIERS			
Name	_____	Name	_____
Address	_____	Address	_____
Telephone	() _____	Telephone	() _____
Fax	() _____	Fax	() _____
Name	_____	Name	_____
Address	_____	Address	_____
Telephone	() _____	Telephone	() _____
Fax	() _____	Fax	() _____

CREDIT LIMIT REQUESTED _____ **TERMS** Net 30 Days from Invoice Date – 1 1/2% service charge per

month on all past due accounts. In the event of collection, customer will be responsible for all collection fees and expenses.

DELIVERY OF MATERIALS: I/We accept all responsibility for shipments of goods and materials by Englert to job sites, my/our place of business, or any other location designated by me/us; whether or not someone is present to receive and sign for such goods and materials.

BANKING REFERENCES

Company Checking Account (Name of Bank) _____ Account No. _____
 Loans (Name of Bank) _____ Account No. _____

HAVE YOU SIGNED ANY PERSONAL GUARANTEES, FINANCING STATEMENTS OR ANY OTHER SECURITY FOR THE PURPOSE OF SECURING CREDIT? YES ___ NO ___

IS THERE ANY PREVIOUS BANKRUPTCY, INSOLVENCY OR SUITS INVOLVING THE PRINCIPALS PERSONALLY OR ANY COMPANY IN WHICH PRINCIPALS HAVE BEEN CONNECTED? YES _____ NO _____. IF YES, GIVE DETAILS.

PERSONAL GUARANTY: In order to induce you to extend credit to the above named corporation and in consideration of your extending credit to said corporation, at any time or from time to time, at my/our request. I/We jointly and severally guarantee prompt, primary and immediate payment of any sums or credit advanced. This is a continuing guarantee; notice of its acceptance is hereby waived. It is hereby understood that Englert Inc. will use the information provided to obtain personal, as well as, commercial credit reports in order to process this application.

Personal Guaranty Signed By:

SIGNATURE

SIGNATURE

SIGNATURE

SIGNATURE

Application Signed By:

OR MAIL TO: 1200 AMBOY AVE. PERTH AMBOY, NJ 08861

PHONE: (732)826-8614- CREDIT DEPARTMENT. EXT. 3954



ADDENDUM A

THE FAIR CREDIT REPORTING ACT

Applicant acknowledges and agrees that Creditor and its subsidiaries, divisions and affiliates (collectively "Creditor") may utilize outside credit reporting services to obtain information on Applicant. In the event Applicant is/are individual(s), the signing of the Application shall constitute authorization under the Fair Credit and Reporting Act to Creditor and its Agents to utilize consumer credit reporting agencies to provide reports on said individual(s) in order to permit Creditor to appropriately evaluate the extension of any business credit. The authorization will remain valid and enforceable until Applicant expressly revokes authorization in writing and served on Creditor by registered or certified mail.

In accordance with the terms and conditions listed above, Applicant hereby authorizes Creditor to obtain commercial credit reports and to share this authorization, and any information contained therein.

SIGNATURE REQUIRED

APPLICANT:

By: _____
Signature

Print Name

Social Security Number

Personal Address

ATTEST:

By: _____
Witness Signature Date

Print name

APPLICANT:

By: _____
Signature

Print Name

Social Security Number

Personal Address

ATTEST:

By: _____
Witness Signature Date

Print name

Aluminum Gutter Coils – 5” (11-3/4” Wide)

PART NO.	COLOR COMBO	GAUGE			COIL QTY.
		.025	.027	.032	
00336B	Hi Gloss	•			1 roll
00335B	Hi Gloss		•		1 roll
00335E	Brown/Black		•		1 roll
00335L	Lo Gloss		•		1 roll
00335W	Eggshell /Wicker		•		1 roll
00335V	Linen/Ivory		•		1 roll
00335M	Light Gray/Musket		•		1 roll
00338Y	Cream/Clay		•		1 roll
00338Z	Dark Gray/Bronze		•		1 roll
00351R	Dark Green/Red		•		1 roll
00334B	Hi Gloss			•	1 roll
00350A	Brown/Black			•	1 roll
00350L	Low Gloss			•	1 roll
00334W	Eggshell/Wicker			•	1 roll
00334V	Linen/Ivory			•	1 roll
00350M	Light Gray/Musket			•	1 roll
00350Y	Cream/Clay			•	1 roll
00350Z	Dark Gray/Bronze			•	1 roll
00334R	Dark Green/Red			•	1 roll

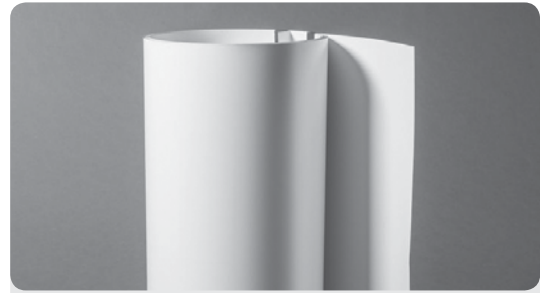

SPECIFICATIONS:

- Available in .025 Hi Gloss only
- All other colors in .027 & .032 Gauge
- Polyester, Castle Clad paint finish
- 20 year pro rated finish warranty
- Cut to length coil available

Aluminum Gutter Coils - 5” (11-3/4” Wide) Mini (Boxed) Coils 150’ - 0”

PART NO.	COLOR COMBO	GAUGE		COIL QTY.
		.027	.032	
00755B	Hi Gloss	•		1 roll
00756A	Brown/Black	•		1 roll
00756L	Lo Gloss	•		1 roll
00756W	Eggshell/Wicker	•		1 roll
00756V	Linen/Ivory	•		1 roll
00757H	Light Gray/Musket	•		1 roll
00756Y	Cream/Clay	•		1 roll
00755G	Dark Gray/Bronze	•		1 roll
00756R	Dark Green/Red	•		1 roll
00758B	Hi Gloss		•	1 roll
00758A	Brown/Black		•	1 roll
00758P	Lo Gloss		•	1 roll
00758W	Eggshell /Wicker		•	1 roll
00758V	Linen/Ivory		•	1 roll
00758T	Light Gray/Musket		•	1 roll
00758Y	Cream/Clay		•	1 roll
00758X	Dark Gray/Bronze		•	1 roll
00758R	Dark Green/Red		•	1 roll



SPECIFICATIONS:

- Available in 150 ft. Rolls (Boxed) in .027 & .032 (gauges)
- Polyester, Castle Clad paint
- 20 year pro rated finish warranty
- Cut to length coil available

Aluminum Gutter Coils – 6” (15” wide)

PART NO.	COLOR COMBO	GAUGE		COIL QTY.
		.027	.032	
00356B	Hi Gloss	•		1 roll
00356A	Brown/Black	•		1 roll
00356E	Lo Gloss	•		1 roll
00356W	Eggshell /Wicker	•		1 roll
00356V	Linen/Ivory	•		1 roll
00355M	Light Gray/Musket	•		1 roll
00355D	Cream/Clay	•		1 roll
00354R	Dark Green/Red	•		1 roll
00356K	Dark Gray/Bronze	•		1 roll
00357B	Hi Gloss		•	1 roll
00357A	Brown/Black		•	1 roll
00355L	Low Gloss		•	1 roll
00357W	Eggshell /Wicker		•	1 roll
00357V	Linen/Ivory		•	1 roll
00358M	Light Gray/Musket		•	1 roll
00357Y	Cream/Clay		•	1 roll
00357R	Dark Green/Red		•	1 roll
00355Z	Dark Gray/Bronze		•	1 roll



SPECIFICATIONS:

- Available in .027 & .032 (gauge)
- Polyester, Castle Clad paint
- 20 year pro rated finish warranty
- Cut to length coil available

GUTTER COILS

Aluminum Gutter Coils - 6" (15" Wide) Mini (Boxed) Coils 150' - 0"

PART NO.	COLOR COMBO	GAUGE .032	COIL QTY.
00752B	Hi Gloss	•	1 roll
00752A	Brown/Black	•	1 roll
00753L	Lo Gloss	•	1 roll
00752W	Eggshell/Wicker	•	1 roll
00752V	Linen/Ivory	•	1 roll
00752M	Light Gray/Musket	•	1 roll
00752Y	Cream/Clay	•	1 roll
00752G	Dark Gray/Bronze	•	1 roll
00752R	Dark Green/Red	•	1 roll

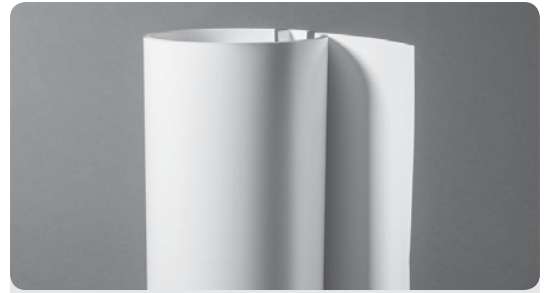

SPECIFICATIONS:

- Available in 150 ft. Rolls (Boxed) in .032 gauge only
- Polyester, Castle Clad paint
- 20 year pro rated finish warranty
- Cut to length coil available

Aluminum Trim Coils - .019 (50 FT. BOXED ROLLS)

PART NO.	COLOR COMBO	WIDTH		LENGTH Ft.	BOX QTY.
		24"	13.812		
00708C	White/White	•		50	1 roll
00708L	Bronze/White	•		50	1 roll
00708A	Brown/White	•		50	1 roll
00705E	Black/Brown	•		50	1 roll
00708B	PVC/White	•		50	1 roll
00700H	Txt Ivory/Txt Light Gray	•		50	1 roll
00700K	Txt Coal Gray/Txt Musket	•		50	1 roll
00700L	Txt White/Txt Brown	•		50	1 roll
00700R	Txt Green/Txt Red	•		50	1 roll
00700S	Txt Eggshell/Txt Wicker	•		50	1 roll
00700T	Txt Terratone/Txt Tan	•		50	1 roll
00700Y	Txt Cream/Txt Clay	•		50	1 roll
00721B	Hi Gloss White		•	50	1 roll
00721C	Brown		•	50	1 roll
00721D	Clay		•	50	1 roll
00721E	Black/Linen		•	50	1 roll
00721I	Ivory		•	50	1 roll
00721J	Light Gray/Dark Gray		•	50	1 roll
00721K	Musket		•	50	1 roll
00721L	Lo Gloss White		•	50	1 roll
00721N	Cream		•	50	1 roll
00721R	Dark Green/Red		•	50	1 roll
00721S	Eggshell		•	50	1 roll
00721W	Wicker		•	50	1 roll
00721Z	Bronze		•	50	1 roll



SPECIFICATIONS:

- 24" x 50' Roll Polyester Finish and Textured Trim Coil
- 24" x 50' Roll PVC White Only
- 13.812" x 50' Roll Polyester Finish
- Cut to length coil available



Aluminum Downspouts (2 X 3)

COLOR	PART NO.	GAUGE		LENGTH FT.	BOX QTY.
		.016	.019		
Hi Gloss	00113B	•		10	100
Hi Gloss	00111B		•	8	80
Hi Gloss	00110B		•	10	100
Lo Gloss	00110L		•	10	100
Brown	00110C		•	10	100
Clay	00110D		•	10	100
Light Gray	00110H		•	10	100
Black	00110F		•	10	100
Dark Gray	00110K		•	10	100
Ivory	00110I		•	10	100
Musket	00110M		•	10	100
Cream	00110N		•	10	100
Linen	00110V		•	10	100
Wicker	00110W		•	10	100
Bronze	00110Z		•	10	100
Eggshell	00110S		•	10	100
Green	08302F		•	10	100
Red	08302R		•	10	100

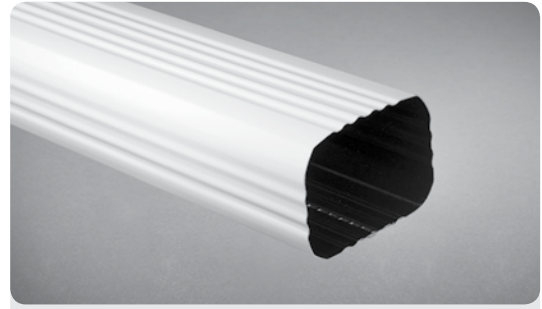

SPECIFICATIONS:

- Available in .016 gauge Hi Gloss only,
- Available in .019 gauge all colors

Aluminum Downspouts (3 X 4)

COLOR	PART NO.	GAUGE		LENGTH FT.	BOX QTY.
		.019			
Hi Gloss	00115B	•		10	100
Brown	00115C	•		10	100
Clay	00115D	•		10	100
Light Gray	00115H	•		10	100
Black	08315E	•		10	100
Dark Gray	00115K	•		10	100
Ivory	00115I	•		10	100
Lo Gloss	00115L	•		10	100
Musket	00115M	•		10	100
Cream	00115N	•		10	100
Linen	00115V	•		10	100
Wicker	00115W	•		10	100
Bronze	00115Z	•		10	100
Eggshell	00116S	•		10	100
Green	08315F	•		10	100
Red	08315R	•		10	100

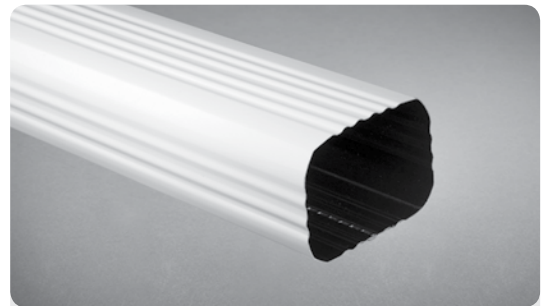

SPECIFICATIONS:

- Available in .019 gauge all colors

Aluminum Elbows (2 X 3)

COLOR	PART NO.		GAUGE		BOX QTY.
	STYLE A	STYLE B	.019	.016	
Hi Gloss	00118B	00124B		•	32 pcs.
Hi Gloss	00120B	00127B	•		32 pcs.
Brown	00120C	00127C	•		32 pcs.
Clay	00120D	00127D	•		32 pcs.
Light Gray	00120H	00127H	•		32 pcs.
Black	00120A	00127A	•		32 pcs.
Dark Gray	00120K	00127K	•		32 pcs.
Ivory	00120I	00127I	•		32 pcs.
Lo Gloss	00120L	00127L	•		32 pcs.
Musket	00120M	00127M	•		32 pcs.
Cream	00120N	00127N	•		32 pcs.
Linen	00120V	00127V	•		32 pcs.
Wicker	00120W	00127W	•		32 pcs.
Bronze	00120Z	00127Z	•		32 pcs.
Eggshell	00120S	00127S	•		32 pcs.
Green	08304F	08305F	•		32 pcs.
Red	08304R	08305R	•		32 pcs.



SPECIFICATIONS:

- Available in .019 gauge all colors A & B
- Available in .016 gauge Hi Gloss A & B

ELBOWS

Aluminum Elbows (3 X 4)

COLOR	PART NO.		GAUGE .019	BOX QTY.	
	STYLE A	STYLE B		STYLE A	STYLE B
Hi Gloss	00121B	00123B	•	32 pcs.	30 pcs.
Brown	00121C	00123C	•	32 pcs.	30 pcs.
Clay	00121D	00123D	•	32 pcs.	30 pcs.
Black	08316E	08317E	•	32 pcs.	30 pcs.
Light Gray	00121H	00123H	•	32 pcs.	30 pcs.
Ivory	00121I	00123I	•	32 pcs.	30 pcs.
Dark Gray	00121K	00123K	•	32 pcs.	30 pcs.
Lo Gloss	00121L	00123L	•	32 pcs.	30 pcs.
Musket	00121M	00123M	•	32 pcs.	30 pcs.
Cream	00121N	00123N	•	32 pcs.	30 pcs.
Eggshell	00121S	00123S	•	32 pcs.	30 pcs.
Linen	00121V	00123V	•	32 pcs.	30 pcs.
Wicker	00121W	00123W	•	32 pcs.	30 pcs.
Bronze	00121Z	00123Z	•	32 pcs.	30 pcs.
Green	08316F	08317F	•	32 pcs.	30 pcs.
Red	08316R	08317R	•	32 pcs.	30 pcs.



SPECIFICATIONS:

- Available in .019 gauge all colors A & B



Aluminum Zig Zag Elbow (2 X 3)

COLOR	PART NO.	PART NO.
	10.25 (1-1/2" OFFSET) 12 PCS.	12.75 (3" OFFSET) 25 PCS.
Hi Gloss White	00167Z	00167Y
Brown	00186C	00167C
Clay	00186D	00166D
Black	00186E	00166E
Light Gray	00186H	00167H
Ivory	00186I	00167I
Dark Gray	00186K	00167K
Lo Gloss White	00186L	00166L
Musket	00186M	00167M
Cream	00186N	00167N
Eggshell	00186S	00167S
Linen	00186V	00167V
Wicker	00186W	00167W
Bronze	00186Z	00166Z
Red	00186R	00167R
Dark Green	00186F	00166F



Aluminum Zig Zag Elbow (3 X 4)

COLOR	PART NO.	BOX QTY.
High Gloss White	00187B	16 pcs.
Brown	00187C	16 pcs.
Clay	00187D	16 pcs.
Black	00187E	16 pcs.
Green	00187F	16 pcs.
Light Gray	00187H	16 pcs.
Ivory	00187I	16 pcs.
Dark Gray	00187K	16 pcs.
Lo Gloss White	00187L	16 pcs.
Musket	00187M	16 pcs.
Cream	00187N	16 pcs.
Red	00187R	16 pcs.
Eggshell	00187S	16 pcs.
Linen	00187V	16 pcs.
Wicker	00187W	16 pcs.
Bronze	00187Z	16 pcs.



ELBOWS

Aluminum End Caps - 5"

COLOR	GAUGE .027		GAUGE .016 (REG)		BOX QTY.
	LEFT PART NO.	RIGHT PART NO.	LEFT PART NO.	RIGHT PART NO.	
Hi Gloss	00130B	00131B	00133B	00132B	60 pcs.
Brown	00130C	00131C			60 pcs.
Lo Gloss	00130L	00131L			60 pcs.
Clay	00130D	00131D			60 pcs.
Light Gray	00133H	00132H			60 pcs.
Black	00130A	00131A			60 pcs.
Ivory	00130I	00131I			60 pcs.
Dark Gray	00130K	00131K			60 pcs.
Musket	00130M	00131M			60 pcs.
Cream	00130S	00131S			60 pcs.
Linen	00130V	00131V			60 pcs.
Eggshell	00133S	00132S			60 pcs.
Wicker	00133W	00132W			60 pcs.
Bronze	00130Z	00131Z			60 pcs.
Green	08307F	08308F			60 pcs.
Red	00130R	00131R			60 pcs.

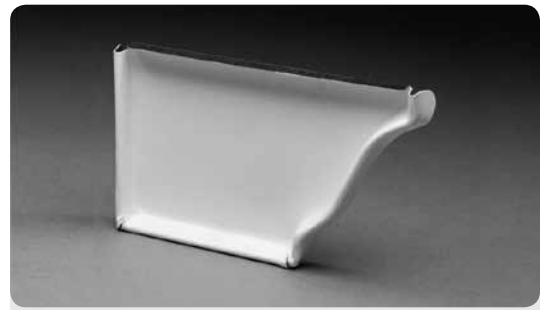

SPECIFICATIONS:

- Available in .027 gauge all colors L & R
- Available in .016 gauge (regular)
Hi Gloss only L & R

END CAPS

Aluminum End Caps - 6"

COLOR	LEFT PART NO.	RIGHT PART NO.	BOX QTY.
Hi Gloss	00136B	00137B	36 pcs.
Brown	00136C	00137C	36 pcs.
Lo Gloss	00136L	00137L	36 pcs.
Clay	00136D	00137D	36 pcs.
Light Gray	00136H	00137H	36 pcs.
Black	00136A	00137A	36 pcs.
Dark Gray	00136K	00137K	36 pcs.
Ivory	00136I	00137I	36 pcs.
Musket	00136M	00137M	36 pcs.
Cream	00136N	00137N	36 pcs.
Linen	00136V	00137V	36 pcs.
Wicker	00136W	00137W	36 pcs.
Bronze	00136Z	00137Z	36 pcs.
Eggshell	00136S	00137S	36 pcs.
Green	08311F	08310F	36 pcs.
Red	00136R	00137R	36 pcs.



SPECIFICATIONS:

- Available in .027 gauge all colors L & R



Aluminum Mitres – 5”/6” Strip

COLOR	5" INSIDE PART NO.	5" OUTSIDE PART NO.	6" INSIDE PART NO.	6" OUTSIDE PART NO.	BOX QTY.
Hi Gloss	00140B	00141B	00146B	00147B	20 pcs.
Brown	00140C	00141C	00146C	00147C	20 pcs.
Clay	00140D	00141D	00146D	00147D	20 pcs.
Green	00140F	08309F	00146G	00147G	20 pcs.
Light Gray	00140H	00141H	00146H	00147H	20 pcs.
Ivory	00140I	00141I	00146I	00147I	20 pcs.
Dark Gray	00140K	00141K	00146K	00147K	20 pcs.
Lo Gloss	00140L	00141L	00146L	00147L	20 pcs.
Musket	00140M	00141M	00146M	00147M	20 pcs.
Cream	00140N	00141N	00146N	00147N	20 pcs.
Red	00140R	00141R	00146R	00147R	20 pcs.
Eggshell	00140S	00141S	00146S	00147S	20 pcs.
Wicker	00140W	00141W	00146W	00147W	20 pcs.
Bronze	00140Z	00141Z	00146Z	00147Z	20 pcs.
Linen	00140V	00141V	00146V	00147V	20 pcs.
Black	00140A	00141A	00146E	00147E	20 pcs.

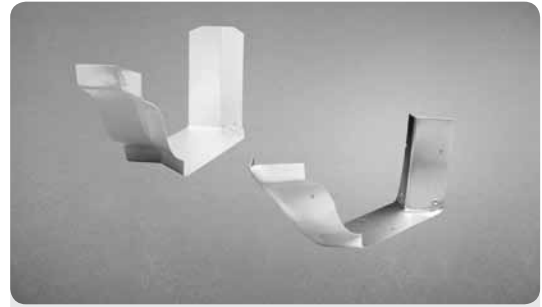

SPECIFICATIONS:

- Available 5" and 6" in all colors, Inside & Outside

Aluminum Mitres – 5”/6” Box

COLOR	5" INSIDE PART NO.	5" OUTSIDE PART NO.	6" INSIDE PART NO.	6" OUTSIDE PART NO.	BOX QTY.
Hi Gloss	00142B	00143B	00144B	00145B	20 pcs.
Brown	00142C	00143C	00144C	00145C	20 pcs.
Clay	00142D	00143D	00144D	00145D	20 pcs.
Green	00142F	00143F	00144G	00145G	20 pcs.
Light Gray	00142H	00143H	00144H	00145H	20 pcs.
Ivory	00142I	00143I	00144I	00145I	20 pcs.
Dark Gray	00142K	00143K	00144K	00145K	20 pcs.
Lo Gloss	00142L	00143L	00144L	00145L	20 pcs.
Musket	00142M	00143M	00144M	00145M	20 pcs.
Cream	00142N	00143N	00144N	00145N	20 pcs.
Red	00142R	00143R	00144R	00145R	20 pcs.
Eggshell	00142S	00143S	00144S	00145S	20 pcs.
Wicker	00142W	00143W	00144W	00145W	20 pcs.
Bronze	00142Z	00143Z	00144Z	00145Z	20 pcs.
Linen	00142V	00143V	00144V	00145V	20 pcs.
Black	00142E	00143A	00144E	00145E	20 pcs.

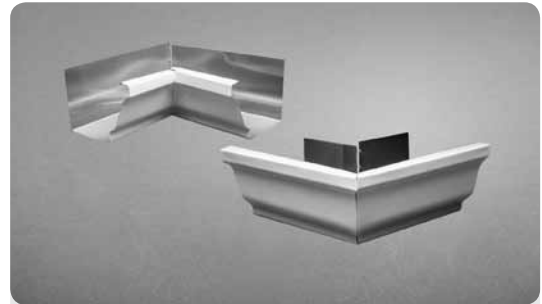

SPECIFICATIONS:

- Available 5" & 6" in all colors, Inside & Outside

MITRES

Aluminum Mitres - 5"/6" Bay

COLOR	5" INSIDE PART NO.	5" OUTSIDE PART NO.	6" INSIDE PART NO.	6" OUTSIDE PART NO.	BOX QTY.
Hi Gloss	00149B	00148B	00153B	00151B	20 pcs.
Brown	00149C	00148C	00153C	00151C	20 pcs.
Clay	00149D	00148D	00153D	00151D	20 pcs.
Green	00149G	00148G	00153G	00151G	20 pcs.
Light Gray	00149H	00148H	00153H	00151H	20 pcs.
Ivory	00149I	00148I	00153I	00151I	20 pcs.
Dark Gray	00149P	00148Y	00153K	00151K	20 pcs.
Lo Gloss	00149L	00148L	00153L	00151L	20 pcs.
Musket	00149T	00148T	00153M	00151M	20 pcs.
Cream	00149N	00148N	00153N	00151N	20 pcs.
Red	00149R	00148R	00153R	00151R	20 pcs.
Eggshell	00149S	00148S	00153S	00151S	20 pcs.
Wicker	00149W	00148W	00153W	00151W	20 pcs.
Bronze	00149Z	00148Z	00153Z	00151Z	20 pcs.
Linen	00149V	00148V	00153V	00151V	20 pcs.
Black	00149E	00148E	00153E	00151E	20 pcs.

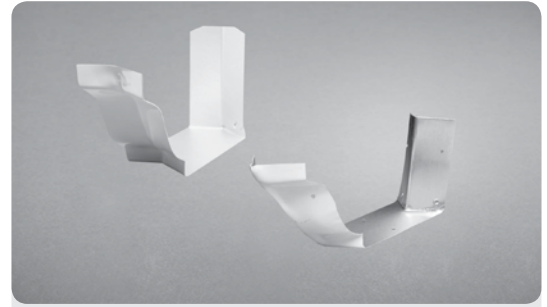

SPECIFICATIONS:

- Available 5" & 6" in all colors, Inside & Outside

Aluminum Hangers - No Screw

PART NO.	DESCRIPTION	BOX QTY.
00215X	5" H.D. Hidden Hanger	400
00223X	6" H.D. Hidden Hanger	400
00218A	5" Canadian Bar Hanger	400
00218B	5" Canadian Bar Hanger	100
00218D	6" Canadian Bar Hanger	100
00217F	7" Canadian Bar Hanger (Steel)	200
00217G	7" Canadian Bar Hanger (Stainless Steel)	100

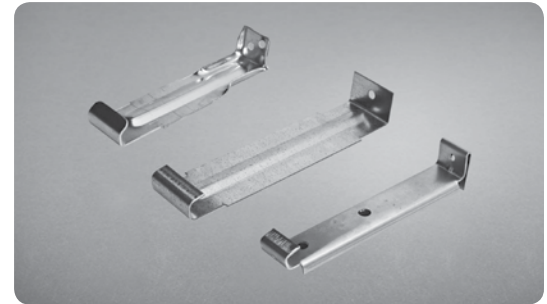

Aluminum Hangers - FSH Bar

PART NO.	DESCRIPTION	BOX QTY.
00231A	FSH Hanger	400

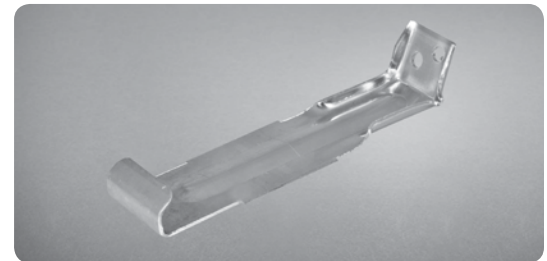

Aluminum Hangers - SS T Bar

PART NO.	DESCRIPTION	BOX QTY.
00210A	5" SS T Bar Hanger	200
00224B	6" T Bar Hanger H-9	100
00225A	5" Suspended SS T Bar Hanger	200
00203R	5" (E) Hanger SST	100
00204R	5" (E) Hanger SST - Strap	100

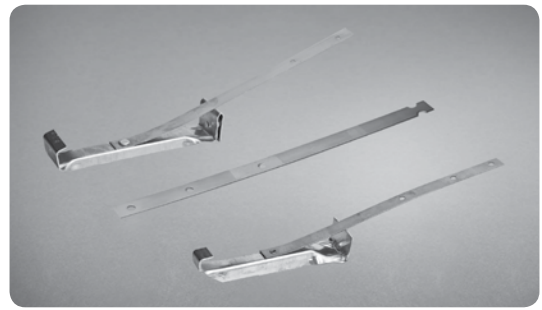

Aluminum - Wrap Around

PART NO.	DESCRIPTION	BOX QTY.
00211B	Wrap Around Strap Hanger	120



Aluminum Hangers - Fascia Bracket

PART NO.	DESCRIPTION	BOX QTY.
00213B	5" Fascia Bracket	100

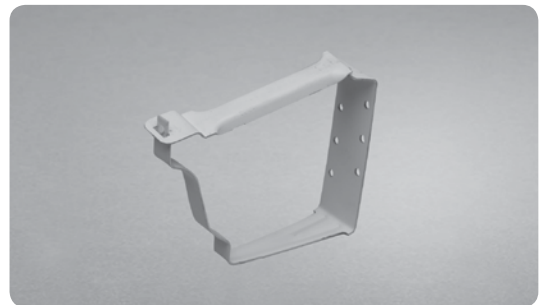

Aluminum Hangers With Screw

PART NO.	DESCRIPTION	BOX QTY.
00215F	5" (E) Hanger with Screw (Clip/Non-Hem Back)	300
00215K	6" (E) Hanger with Screw (Clip/Non-Hem Back)	250
00215G	5" (E) Hanger with Screw (No Clip/Hem Back)	300
00215L	6" (E) Hanger with Screw (No Clip/Hem Back)	250
00215T	5" (E) Hanger with Screw (No Clip/Hem Back)	100
00215IX	5" (E) Hanger with Screw (No Clip/Hem Back)	100
00223H	6" Hanger (No Clip/ Hem Back)	300
00223K	6" Hanger No Clip w/ Screw (No Clip/ Hem Back)	300
00215D	5" Hanger with Screw (BUCH 950)	500
00223D	6" Hanger with Screw (BUCH 990)	300
00215S	5" (E) Hanger with Screw (White A52)	100
00223S	6" (E) Hanger with Screw (White A52)	75

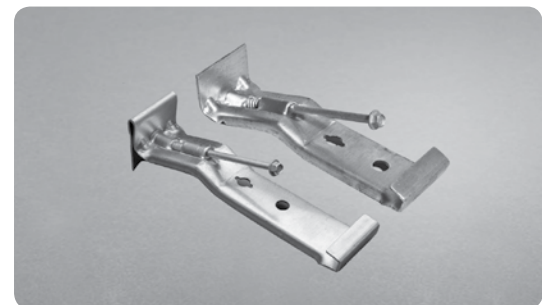

HANGERS

Gutter Attachment Fasteners – Nails

PART NO.	DESCRIPTION	BOX QTY.
00219A	1" Masonry	5 lbs.
00221A	2" Pallet	5 lbs.
00600B	1-1/4" Trim Nails – White	1 lb.
00600S	1-1/4" Trim Nails – Stainless Steel White	1 lb.

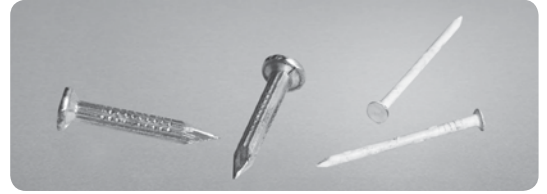

Gutter Attachment Fasteners – Screws

PART NO.	DESCRIPTION	BOX QTY.	BOX QTY.
00982B	#9 x 1-1/2 Screw	*2500/BOX	100 pk.
00982C	#9 x 2-1/2 Screw	*1500/BOX	100 pk.



Gutter Accessories Fasteners – Zip Screws - Box Quantity Only, 1000 Pcs. Per Box

COLOR	1/2" PART NO.	3/4" PART NO.	3/8" STAINLESS PART NO.
White	00980B	00983B	00981B
Brown	00980C	00984C	00981C
Clay	00980D	N/A	00981D
Light Gray	00980H	N/A	00981H
Cream	00980N	N/A	00981N
Wicker	00980W	N/A	00981W
Eggshell	00980Y	N/A	00981Y
Black	00980A	N/A	N/A
Ivory	00980I	N/A	N/A
Dark Gray	00980K	N/A	N/A
Musket	00980M	N/A	N/A
Red	00980R	N/A	N/A
Dark Green	00980U	N/A	N/A
Linen	00980V	N/A	N/A
Bronze	N/A	N/A	N/A
Stainless Steel-Plain	N/A	N/A	00981Z

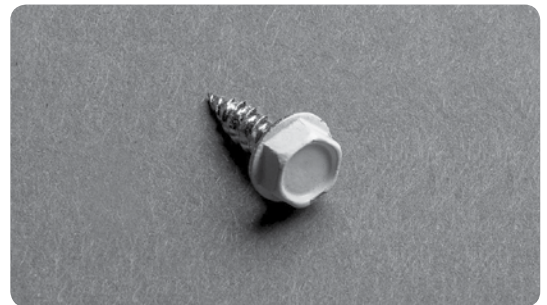

FASTENERS

Gutter Accessories Fasteners – Pop Rivets

PART NO.	COLOR	BOX QTY.	PART NO.	COLOR	BOX QTY.
00260B	White	100 pk.	00260R	Red	100 pk.
00260C	Brown	100 pk.	00260S	Eggshell	100 pk.
00260D	Clay	100 pk.	00260V	Green	100 pk.
00260H	Light Gray	100 pk.	00260W	Wicker	100 pk.
00260I	Ivory	100 pk.	00260L	Linen	100 pk.
00260K	Dark Gray	100 pk.	00260Z	Bronze	100 pk.
00260N	Cream	100 pk.	00260E	Black	100 pk.

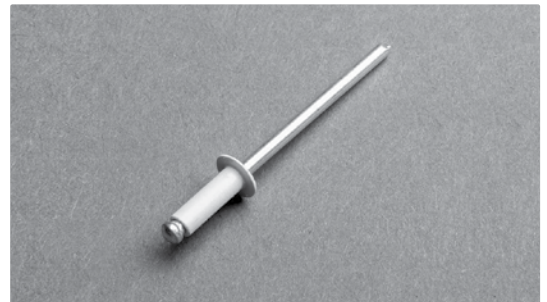

ENGLERT®

Aluminum Drop In Gutter Guards

PART NO.	COLOR	SIZE		BOX QTY.
		5" x 3'	6" x 3'	
00270B	Mesh	•		50 pcs.
00270C	Mesh		•	50 pcs.

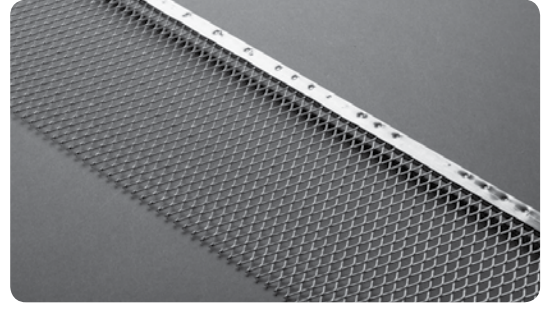

Englert Sureguard Gutter Screen - Made with .027 Aluminum

PART NO.	COLOR	SIZE		BOX QTY.
		3'		
00267C	Gold SureGuard Screen	Covers 5" & 6"		50 pcs.
00267D	White SureGuard Screen	Covers 5" & 6"		50 pcs.

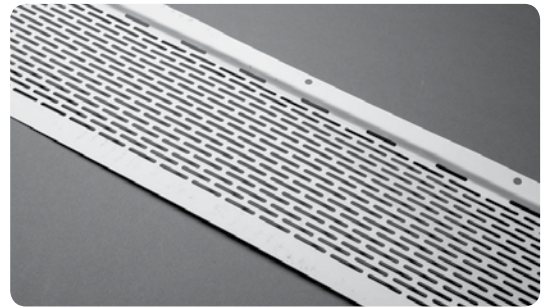

Englert Microguard Gutter Screen - Made With .032 Aluminum

PART NO.	DESCRIPTION	SIZE		BOX QTY.
		3'		
00267T	MicroGuard* Flat	5" x 4 ft.		38 pcs.
00267R	MicroGuard* Prebent	5" x 4 ft.		38 pcs.
00267X	MicroGuard* Reverse Bend	5" x 4 ft.		38 pcs.
00267U	MicroGuard* Flat	6" x 4 ft.		38 pcs.
00267S	MicroGuard* Prebent	6" x 4 ft.		38 pcs.

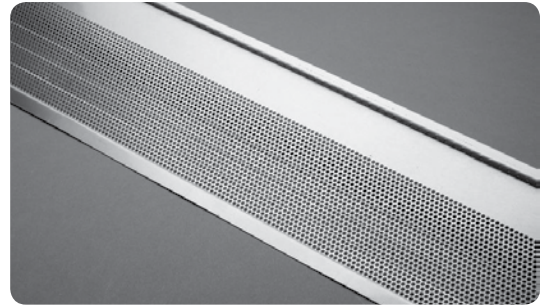

Aluminum Flat Strainer

PART NO.	DESCRIPTION	BOX QTY.
00191A	Flat Strainer	100 pcs.

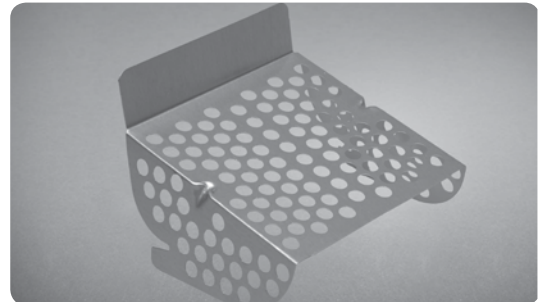

LEAF PROTECTION

Aluminum Downspout - U Clips

COLOR	2" x 3" PART NO.	QTY.	3" x 4" PART NO.	QTY.
Hi Gloss White	00199B	125 pcs.	00198B	65 pcs.
Brown	00197C	125 pcs.	00198C	65 pcs.
Clay	00197D	125 pcs.	00198D	65 pcs.
Black	00197A	125 pcs.	00198E	65 pcs.
Light Gray	00197H	125 pcs.	00198H	65 pcs.
Ivory	00197	125 pcs.	00198I	65 pcs.
Dark Gray	00197K	125 pcs.	00198X	65 pcs.
Lo Gloss White	00197L	125 pcs.	00198L	65 pcs.
Musket	00197M	125 pcs.	00198M	65 pcs.
Cream	00197N	125 pcs.	00198N	65 pcs.
Eggshell	00197S	125 pcs.	00198S	65 pcs.
Linen	00197V	125 pcs.	00198V	65 pcs.
Wicker	00197W	125 pcs.	00198W	65 pcs.
Bronze	00197Z	125 pcs.	00198Z	65 pcs.
Red	00197R	125 pcs.	00198R	65 pcs.
Dark Green	00197F	125 pcs.	00198F	65 pcs.

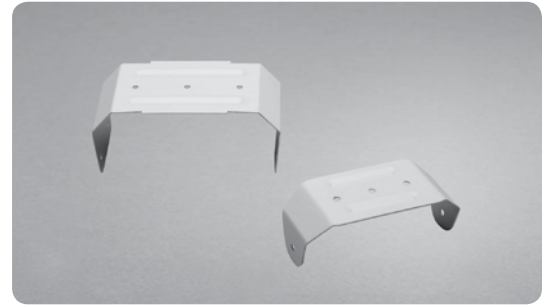

Aluminum Downspout - Pipebands

COLOR	SIZE		BOX QTY.
	2" X 3" PART NO.	3" X 4" PART NO.	
Hi Gloss	00200B	00201B	125 pcs.
Brown	00200C	00201C	125 pcs.
Clay	00200D	00201D	125 pcs.
Black	00200F	002010	125 pcs.
Light Gray	00200H	00201H	125 pcs.
Ivory	00200I	00201I	125 pcs.
Dark Gray	00200K	00201K	125 pcs.
Lo Gloss	00200L	00201L	125 pcs.
Musket	00200M	00201M	125 pcs.
Cream	00200N	00201N	125 pcs.
Eggshell	00200S	00201S	125 pcs.
Linen	00200V	00201V	125 pcs.
Wicker	00200W	00201W	125 pcs.
Green	08312F	08313F	125 pcs.
Red	08312R	08313R	125 pcs.
Bronze	00200Z	00201Z	125 pcs.

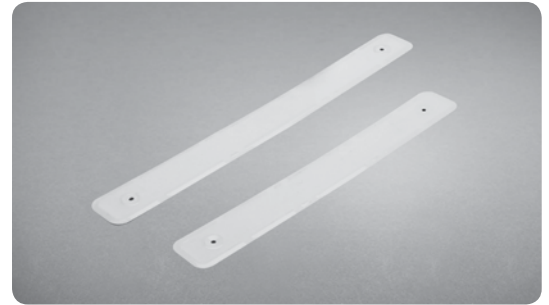

Aluminum Downspout - Cleats

COLOR	PART NO.	BOX QTY.
Hi Gloss	00202A	200 pcs.
Brown	00202C	200 pcs.



Aluminum Funnel - Leader Heads

PART NO.	DESCRIPTION	BOX QTY.
00183B	3" Hi Gloss Funnel	12 pcs.
00170B	3" Leader Head Hi Gloss	12 pcs.
00171A	3" Leader Head Hi Gloss	6 pcs.

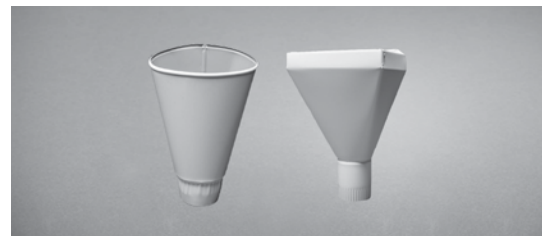

ACCESSORIES



ENGLERT

Aluminum Gutter Wedge – 5”

PART NO.	BOX COLOR	QTY.
00217B	White	150 pcs.
00217C	Brown	150 pcs.

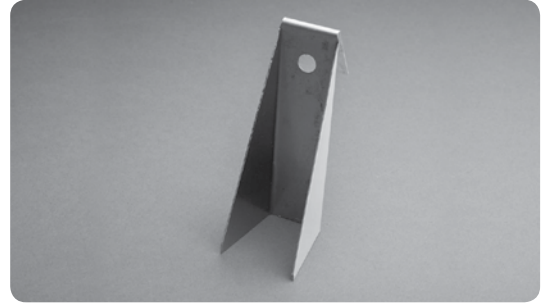

PVC Drain Adapter 2 x 3 x 4

PART NO.	DESCRIPTION	BOX QTY.
01098C	Downspout Adapter 2 x 3 x 4	30 pcs.
01098D	Downspout Adapter 3 x 4 x 4	30 pcs.



Splash Block

COLOR	PART NO.	BOX QTY.
Green	01096A	10 pcs.

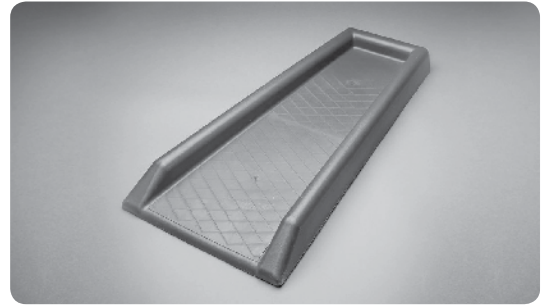

Aluminum Outlets – Rectangular & Round

PART NO.	DESCRIPTION	BOX QTY.
00181W	Rectangular Outlet - 2"x3"	125 pcs.
00176B	Rectangular Outlet - 3"x4"	125 pcs.
00179B	Round White Outlet - 2-3/8"	250 pcs.
00179D	Round M/F Outlet - 2-3/4"	250 pcs.
00177A	Round M/F Outlet - 3-3/8"	100 pcs.



Drip Edge

COLOR	PART NO.	DESCRIPTION	LENGTH IN.
BRT White	00278B	Drip Edge	6"
BRT White	00279B	Drip Edge	4.5"
Brown	00278C	Drip Edge	6"
Brown	00279C	Drip Edge	4.5"

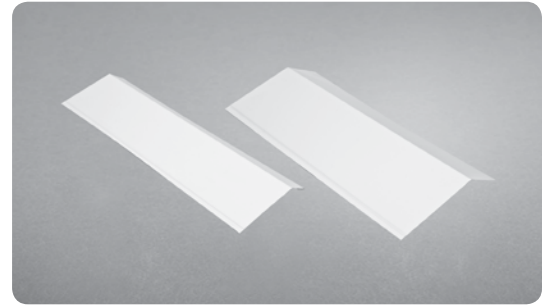

Gutter Caulking & Sealants

PART NO.	DESCRIPTION	BOX QTY.
00290A	Silicone GE Clear 1001	24 tubes
00290B	Silicone GE White 1002	24 tubes
00313A	Englert Sealant Silver 5 oz.	24 tubes
00313B	Englert Sealant White 5 oz.	24 tubes
00316A	Gary Products/Bond Sealant	24 tubes
00319A	Geocel 2300 Clear	24 tubes
00319B	Geocel 2321 Sealant "SPECIAL ORDER"	24 tubes
00319C	Geocel 2320 White 10.32 oz.	24 tubes
00319Z	Geocel 2320 Clear 10.32 oz.	24 tubes
00580B	OSI Caulk White SBR100	12 tubes
00310B	OSI Caulk White Sealant	12 tubes



Gutter Touch Up Paint

PART NO.	COLOR	BOX QTY.	PART NO.	COLOR	BOX QTY.
00292A	Lo Gloss	12 cans	00292N	Cream	12 cans
00292B	Hi Gloss	12 cans	00292R	Red	12 cans
00292C	Brown	12 cans	00292D	Clay	12 cans
00292W	Wicker	12 cans	00293E	Black	12 cans
00292X	Green	12 cans	00292H	Light Gray	12 cans
00292Y	Eggshell	12 cans	00292I	Ivory	12 cans
00292Z	Bronze	12 cans	00292K	Dark Gray	12 cans
00293V	Linen	12 cans	00292M	Musket	12 cans

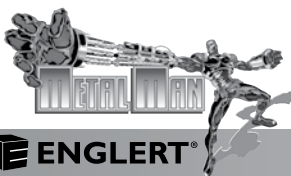

2-In-1 Rivet Gun

PART NO.	DESCRIPTION	WIDTH IN.	LENGTH IN.
00908A	2-in-1 Rivet Gun	N/A	8.5"



SS T Bar Tool

PART NO.	DESCRIPTION	WIDTH IN.	LENGTH IN.
00907A	SS T Bar Tool	N/A	11"



Crimper SL-1

PART NO.	DESCRIPTION	WIDTH IN.	LENGTH IN.
00902A	Crimper SL-1 For End Caps	N/A	8"



Crimper SL-4

PART NO.	DESCRIPTION	WIDTH IN.	LENGTH IN.
00901A	Crimper C-4 For Leader	N/A	8"



Snips – M12N & M14N

PART NO.	DESCRIPTION	WIDTH IN.	LENGTH IN.
00903A	Snips - M12N	N/A	12.5"
00903C	Snips - M14N	N/A	14"



Hole-In-1 Saw

PART NO.	DESCRIPTION	WIDTH IN.	LENGTH IN.
00921A	2 3/8" Hole Saw	2.375"	3.5"
00921E	3 3/8" Hole Saw	3.375"	N/A



Hole Punch

PART NO.	DESCRIPTION	WIDTH IN.	LENGTH IN.
00904A	2-3/8" Hole Punch	2.375"	N/A
00904B	2-3/4" Hole Punch	2.75"	N/A
00904D	3"x 4" Oval Hole Punch	3"	N/A
00904L	3-3/8" Hole Punch	3.375"	N/A



Awl

PART NO.	DESCRIPTION	WIDTH IN.	LENGTH IN.
00900A	Awl	N/A	6"



Lube Stick

PART NO.	DESCRIPTION	WIDTH IN.	LENGTH IN.
00940A	Lube Stick	1" dia.	7.875"



T-Shot Nailing Tool

PART NO.	DESCRIPTION	WIDTH IN.	LENGTH IN.
00906A	T-Shot Nailing Tool	.313" dia.	6"



Englert Gutter Stand

PART NO.	DESCRIPTION
01341D	5"/6" Englert Gutter Stand
01341E	7" Englert Gutter Stand



Series 555 T Machine

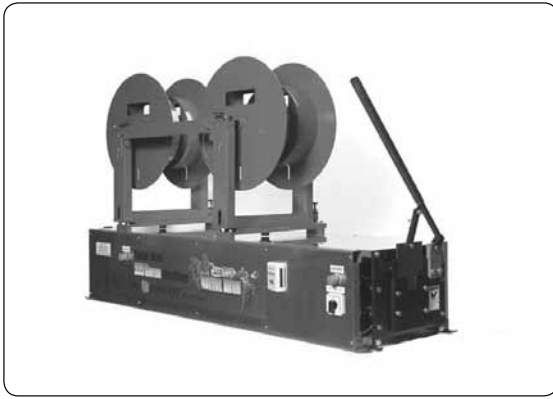

PART NO. 01310P

FEATURES:

- Free floating chromed forming rollers
- Mechanical chop style shear
- Conveniently located forward/reverse switch
- Emergency stop switches located at entry and exit end of machine
- Independently mounted, easily reversible reel stand, with adjustable-width reel
- Limited 5 year parts warranty
- Fits into the back of an 8 ft. (2.44m) pick up truck
- Runs aluminum, copper, painted or galvanized steel
- Welded tubular steel frame

AVAILABLE OPTIONS:

- Gutter stands
- Extra reels
- Mini reel (for Englert's 150 ft. box rolls)
- Cradles
- Additional support stand
- 50 hz. electric motor
- 220V wiring
- CE compliant

Series 555 Machine



PART NO. 01314P

FEATURES:

- Free floating chromed forming rollers
- Mechanical guillotine utilizing double rack and pinion shear
- Exit end and reversing drum switch with exit end 15 amp., 120V., weatherproofed double outlet auxiliary power source and with entry end and exit emergency stop switch
- Two independently mounted easily reversible reel stands, with two adjustable width reels
- Limited 5 year parts warranty
- Fits into the back of an 8 foot (2.44 m) pick up truck
- Runs aluminum, copper, painted or galvanized steel and standard terne-coated steel
- Operation and adjustment manual

AVAILABLE OPTIONS:

- Gutter stands
- Extra reels
- Cradles
- 3rd reel support stand
- 50 hz.
- 220V
- Convenience outlet
- Free float unit
- Mini 150 foot gutter spool
- Footage counter / electronic tape measure
- CE compliant

NEW OPTION

Flat Ribs in bottom of Gutter

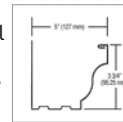

Pencil Ribs in bottom of Gutter

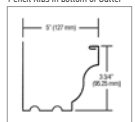

Series 650 Machine

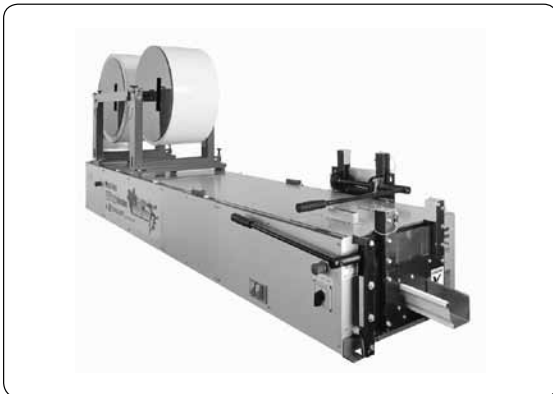

PART NO. 01316P

FEATURES:

- Free floating chrome plated forming rollers
- Mechanical guillotine utilizing double rack and pinion shear
- Two independently mounted, easily reversible reel stands, with two adjustable width reels
- Limited 5 year parts warranty
- Runs aluminum, copper, painted or galvanized steel and standard terne-coated steel

AVAILABLE OPTIONS:

- Gutter stands
- Extra reels
- 3rd reel support stand
- 50 hz.
- 220V
- Convenience outlet
- Coil cradles
- Free float unit
- Mini 150 foot gutter spool
- Footage counter / electronic tape measure
- CE compliant

NEW OPTION

Flat Ribs in bottom of Gutter

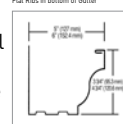

Pencil Ribs in bottom of Gutter

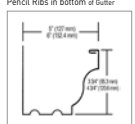

Series 660 Machine

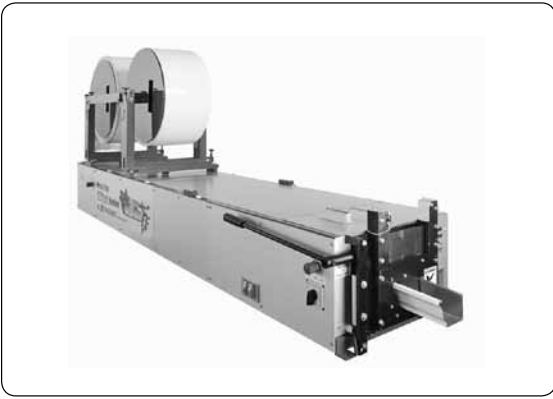

PART NO. 01306P

FEATURES:

- Free floating chromed forming rollers
- Mechanical guillotine utilizing double rack and pinion shear
- Exit end reversing drum switch with exit end 15 amp., 120V., weatherproofed double outlet auxiliary power source and with entry end and exit emergency stop switch
- Two independently mounted easily reversible reel stands, with two adjustable width reels
- Limited 5 year parts warranty
- Runs aluminum, copper, painted or galvanized steel and standard terne-coated steel

AVAILABLE OPTIONS:

- Gutter stands
- Extra reels
- 3rd reel support stand
- 50 hz.
- 220V
- Coil cradles
- Free float unit
- Convenience outlet
- Mini 150 foot gutter spool
- Footage counter / electronic tape measure
- CE compliant

NEW OPTION

Flat Ribs in bottom of Gutter



Pencil Ribs in bottom of Gutter

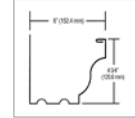

Series 770 Machine



PART NO. 01321P

FEATURES:

- Free floating chromed forming rollers
- Mechanical guillotine utilizing double rack and pinion shear
- Exit end reversing drum switch with exit end 15 amp., 120V., weatherproofed double outlet
- Footage counter / electronic tape measure
- Limited 5 year parts warranty

AVAILABLE OPTIONS:

- Adjustable 4" flange kit (from -5° to 15°) (Part Number 01320P)
- Gutter stands
- Extra reels
- Convenience outlet
- Specially designed trailer (Part Number 01451A)

NEW OPTION

Adjustable Flange Back Profile

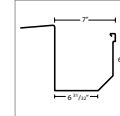

Straight Back Profile

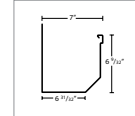

*See roofing catalog for 7" gutter coil and accessories

Industry Best – Five Year Limited Machine Warranty

Englert offers its machine customers a Limited five-year parts and labor warranty from the date of sale on all new Englert gutter roll-forming machines purchased from Englert, only and when operated under normal operating conditions and in strict accordance with any operating manuals or instructions provided at the time of sale. During this period, Englert will repair or replace any part or assembly of the machine manufactured by Englert that it deems defective.

Englert will also repair or replace defective parts and assemblies at the job site or purchaser's shop at an additional charge, including current hourly repair rate plus expenses, and a minimum of 10 business days' notice.

For more information about Englert's Limited five-year parts and labor warranty contact your local Englert representative or visit our website <http://www.englertinc.com/gutter-machines/>.

The Industry's Only Mobile Technical Service

Englert offers its contractors the industry's only mobile technical service fleet for gutter rollforming machinery service and repairs. Unlike competitors who require that machines be shipped to their headquarters for repairs, Englert's fleet of fully equipped mobile service vehicles service our gutter rollforming equipment at your location. Our factory trained machine technicians repair and refurbish machines in hours - not days. And while competitors must load their repaired machines on a common carrier's truck and ship it back to the contractor, an Englert gutter machine serviced onsite is already back in business, servicing your customers.

For more information about Englert's mobile technical service program and service agreements, contact your local Englert sales representative.

Architectural Guide Specifications

SCOPE OF WORK

Furnish all labor, materials, and equipment required to complete installation of Raincarrying System and related work as indicated on drawings or specified herein.

MATERIALS

- A. Gutters shall be made of 3105-H24 aluminum and shall be continuous and seamless [Minimum tensile strength 26,000 psi, minimum yield strength 25,000 psi] or equivalent.
- B. Gutter gauges shall be .032" or .027" (select one as needed) gauge nominal, with 3" x 4" or 2" x 3" (select one) downspouts, [leaders] in .019" gauge;
- C. End caps to be .027" gauge.
- D. Inside and outside mitres to be .027" gauge.
- E. Sealant/Caulking - (select as appropriate):
Parabond Sealer - (silver)
G.E. Silicone - (white, clear and bronze).
Butyl Sealer - (white)
- F. Downspout anchors to be aluminum.
- G. Gutter hangers to be .063" gauge.
- H. Prior to painting, the metal shall receive a pre-treatment to assure for maximum paint adhesion. The exterior finish shall be CastleClad, two-coat system applied in a continuous baked-on process in a single operation, comprising of an acid-based primer and baked-on high performance linear polyester topcoat. The inside of the gutter shall be finished with a polyester gold backer or wash coat.
- I. All accessories used with the Raincarrying System shall have the same CastleClad finish as the gutters.

INSTALLATION, WORKMANSHIP

- A. Before starting work, verify governing dimensions at building; examine, clean and repair if necessary any adjoining work on which this work is in any way dependent for its proper installation.
- B. The Raincarrying System shall be installed in accordance with Manufacturer's recommended procedures. Gutters shall be installed by using appropriate hangers to allow flexibility of movement.
- C. All Gutter Hangers shall be installed by using two 1-1/4" screw shank nails and fastened into solid lumber.
- D. All gutters shall be in continuous length for each elevation (run). No end laps are allowed.
- E. Upon completion, the Contractor shall clean the debris.
- F. Dissimilar materials.
 - 1. Exercise care in placing aluminum in contact with other dissimilar metals or materials that are not compatible with aluminum.
 - 2. Providing adequate insulation/separation wherever necessary, such as by painting or otherwise protecting when they are in contact with aluminum or when drainage from them passes over aluminum.

CERTIFICATION OF COMPLIANCE

The Raincarrying Systems shall meet the following specifications and/or code approvals:

- A. American Architectural Manufacturers Association (AAMA) Specification 1405.1 "Specification for Aluminum Raincarrying Systems."
- B. FHA Minimum Property Standard 4900.1 for One- and Two-Family Dwellings.
- C. FHA Minimum Property Standard 4910.1 for Multi-Family Dwellings.

WARRANTY

The Seamless Aluminum Gutter Raincarrying System shall be covered by a Limited 20-Year, pro-rated and non-transferable Paint Finish Warranty covering labor and materials by the Manufacturer.



Purchasing Tips

PURCHASING A SEAMLESS GUTTER MACHINE

Why should I purchase a seamless gutter machine? **CONTROL.**

How many times are you left waiting to get paid after the siding or roofing has been installed? **TOO MANY TIMES?**

You can run your business with the most experienced applicators, the newest and best trucks, and all the great new tools that are available to the trade.

If you can't get the final payment on the job because your gutter installer can't get the job completed, then now is the time to look into having your own seamless 5", 6" or 5"-6" combination machine.



GUTTER COIL PURCHASING TIPS

When you buy by the pound and sell by the foot, remember the old saying: **"Let The Buyer Beware."**

Many gutter machine repair problems are caused by running coil that is too hard, coil that is slit to the wrong width, coil that has too much wax in the wash coat which causes the coil to slip in the machine.

To know what gauge you are receiving is very important. When buying gutter coil by the pound, being overgauged by one thousandth can cost you additional money per foot.

To find the cost per ft. take the cost per lb. and divide by the yield factor listed below.

EXAMPLE

2.00 per lb cost	025 divide by 2.865 = .69 ft.	2.00 per lb cost 15"	027 divide by 2.078 = .96 ft.
2.00 per lb cost	032 divide by 2.238 = .89 ft.	2.00 per lb cost 15"	032 divide by 1.754 = 1.14 ft.
2.00 per lb cost	027 divide by 2.653 = .75 ft.	2.00 per lb cost 18"	032 divide by 1.477 = 1.35 ft.

The selling price for coil can change but the yield can never change.

YIELD FACTORS = FT. PER LB. COST PER LB.

WIDTH	GAUGE	FEET PER LB.
11-3/4"	025	2.865
11-3/4"	027	2.653
11-3/4"	032	2.238
15"	027	2.078
15"	032	1.754

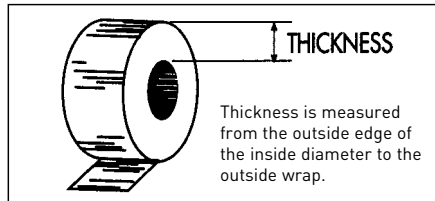

GUTTER COIL THICKNESS CHART

THICKNESS	027 x 11 3/4" LB. / FT.	032 x 11 3/4" LB. / FT.	027 x 15" LB. / FT.	032 x 15" LB. / FT.
1/2"	30/80	30/68	38/80	38/68
3/4"	46/122	46/103	59/122	59/103
1"	62/165	62/139	79/165	79/139
1-1/4"	79/209	79/176	100/209	100/176
1-1/2"	96/255	96/215	122/255	122/215
1-3/4"	114/301	114/254	145/301	145/254
2"	132/349	132/295	168/349	168/295
2-1/4"	150/398	150/336	191/398	191/336
2-1/2"	169/449	169/379	215/449	215/379
2-3/4"	189/500	189/422	240/500	240/422

THICKNESS	027 x 11 3/4" LB. / FT.	032 x 11 3/4" LB. / FT.	027 x 15" LB. / FT.	032 x 15" LB. / FT.
3"	208/553	208/467	266/553	266/467
3-1/4"	229/607	229/512	292/607	292/512
3-1/2"	249/661	249/559	318/661	318/559
3-3/4"	271/718	271/606	345/718	345/606
4"	292/775	292/655	373/775	373/655
4-1/4"	314/834	314/704	401/834	401/704
4-1/2"	337/894	337/755	430/894	430/755
4-3/4"	360/955	360/807	459/955	459/807
5"	384/1018	384/860	489/1018	489/860
5-1/4"	408/1082	408/913	520/1082	520/913

Purchasing Tips

PURCHASING TIPS

GUTTER HANGING SYSTEMS - 101

There are various types of hanging systems that are available. What would be the best type to use for different applications?

1. SST BAR HANGER

To be used when there is no fascia board. This hanger has a stainless steel strap that would be nailed to the roof. The rivet holding the strap to the hanger has been designed to hold the full weight of a typical gutter, when spaced at 24" on center.

2. WRAP AROUND STRAP HANGER

This hanger wraps around the gutter and is nailed to the roof.

3. FASCIA BRACKET

This hanger is nailed or screwed to the fascia board and the gutter sits inside the hanger.

4. SPIKE AND FERRULE

Available in white and colors and used with a ferrule internally, this system pins the gutter face directly to the fascia board.

5. HIDDEN HANGER

This is an internal hanger and can be attached from the gutter to the fascia board with either a nail or screw. If using a nail the use of a slant fin tool will help with the installation.

6. HIDDEN HANGER WITH SCREW

This is an internal hanger and has the screw attached to the hanger. It is usually installed with the use of a cordless drill.

7. CANADIAN BAR HANGER

This is an internal hanger and can be attached from the gutter to the fascia board with either a nail or screw.

8. SUSPENDED SST BAR HANGER

To be used when the gutter has a hem back on it and there is no fascia board to nail or screw into. The strap is attached to the roof.

9. FSH HANGER

This is a hidden hanger to be installed with either a screw or nail.

10. COMBINATION HANGER

Attaches to back lip hem on gutter then is either nailed or screwed to the fascia board.

RATIOS

Did you know you could plan your inventories by using ratios.

What is a ratio?

A ratio is something that is compared to something else.

EXAMPLE:

For every 2 hands there are 10 fingers. The ratio would be 10 to 2.

Englert has kept track of ratios since 1966. We use them in sales projections and you can use them in planning your usage of materials and inventory.

EXAMPLE:

H&H Gutter Company will use 180 ft. of gutter for their next job application. Therefore, they need approximately 90 ft. of leader, 20 elbows, 13 endcaps, 90 gutter hangers, etc.

By dividing the number in the right-hand column (see chart above) into the gutter footage used for the entire job application (in this example it was 180 ft.), you can determine how much to order on your accessory items.

Therefore if you are keeping an inventory, Englert can help you manage it by the use of numbers and ratios.

EXAMPLE:

If you purchase 1 roll of gutter coil at 400 lbs. 027 gauge you will have approximately 1061 ft. of gutter. $2.653 \times 400 = 1061$ ft.

Therefore you should have the following back up for accessories.

Leader	500 ft.
Elbows	120 pc.
End Caps	60 pc. 60 pc. (Right & Left)
Gutter Hangers	500 pc.
Mitres	20 pc.
Leader Hangers	100 pc.
Screws	1 box
Sealant	1 box
Outlet Tubes	1 box

(NOTE: Full box quantities shown.)

GUTTER RATIO CHART

For every piece or foot of the following:

For every piece or foot of the following:	You will need this many feet of gutter
Leader	2
Elbows	9
End Caps	14
Gutter Hangers	2
Leader Hanger	10
Screws	4
Mitres	88
Outlet Tubes	20
Sealant	240



Maintenance Of Seamless Gutter & Rainware Products

NORMAL CONDITIONS

The CastleClad Finish on your seamless gutter and rainware products is one like any other colored or painted surface, subject to chalking and some degree of color change, due to normal atmospheric weather conditions and dirt accumulation, depending on the atmosphere to which your subdivisions exposed. Under normal conditions, objectionable superficial surface dirt can be removed by washing down the gutters with a garden hose and a soft bristle brush. While weathering occurs through exposure to the sunlight or extreme weather conditions, the CastleClad Finish resists the associated problems of peeling, chipping, and blistering. In addition to resistance of chipping, peeling, and blistering, the CastleClad Coatings are formulated to resist fading (color change) due to normal weathering for a reasonable period of time, depending on the atmospheric conditions to which your home is exposed. The CastleClad Finish has built-in color retention ability. It resists dirt and stands up to the environment better. The resistance to dirt adhesion provides a self-cleaning feature, which helps to greatly minimize loose surface dirt, caused by normal rainfall.

UNUSUAL CONDITIONS

In industrial areas, where a more thorough cleaning is necessary for stains resulting from tree sap, insecticides, chimney fumes, etc., the finish should be washed with a sponge or soft bristle brush and a solution of detergent and water (1/3 cup of detergent such as Tide, per gallon of water, for example). Immediately rinse surfaces thoroughly with a garden hose. Avoid vigorous rubbing as this can cause the coating to lose its luster and finish. To minimize streaking, wash from bottom to top.

In some geographic locations, mildew may appear as black spots. Mildew can be removed by treating the gutters with the following solution:

SOLUTION:

- 1/3 cup detergent (such as Tide)
- 2/3 cup Soilax
- 1 quart liquid bleach (such as Clorox)
- 3 quarts water

CAUTION:

Greater concentrations may cause damage to the finish. Do not use abrasive or solvent type cleaners or paint removers.



The solution can either be sprayed or sponge applied with a soft bristle brush. Allow it to remain for 15 to 20 minutes, and then rinse clean with a hose. Adequate rinsing is recommended to assure cleansing of the finish and further dilute the solution so as not to harm shrubbery under gutter and fascia areas. Test the solution or clean a small area before application to large areas. Avoid skin contact or getting the solution into your eyes.

CAULKING COMPOUNDS AND TAR

Mineral spirits may be used in reasonable quantities to remove caulking compounds or tar from the finish. Rinse with clear water.

Association Memberships and Testing Organizations



Visit www.englertinc.com or call 1-800-ENGLERT
for the Englert locations nearest you.



1200 Amboy Avenue, Perth Amboy, NJ 08861 Phone: (732) 826-8614
Fax: (732) 826-8865 www.englertinc.com

